



21-22 July 2011

Kuala Lumpur Convention Centre (KLCC), Malaysia

Residual Current Devices (RCD) in Electrical Installations

Presented By

Dahari M. Siran

Chairman of Electrical Safety & Quality

TEEAM

Organized by:



1. Introduction
2. Definition
3. Standards & references
4. Environmental conditions
5. General consideration
6. Selection of RCDs
7. Effects of electricity on human body
8. Tripping of RCDs
9. RCCBs – The problems (summary)
10. RCCBs – The solutions (summary)



21-22 July 2011, KLCC

1. INTRODUCTION



To highlights the main parameters influencing protection reliability and provides information on how to install and operate residual current protection devices in relationship to their environmental conditions after installation.

2. DEFINITION



RCD

– A generic term for all types of residual current devices.

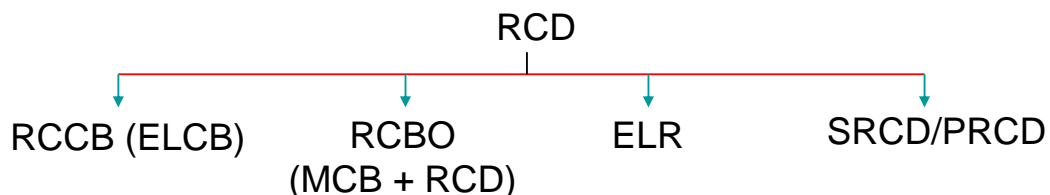

Residual current:

Vector sum of the instantaneous values of current flowing in the main circuit of an RCD.

3. STANDARDS & REFERENCES



The relevant MS IEC standards covering RCDs intended for household and similar uses are as follows:

1. MS IEC 61008 - RCCBs for household and similar use;
2. MS IEC 61009 - RCBOs for household and similar use; and
3. MS IEC 61543 - EMC requirements for RCDs.
4. MS 62350 – Guidance for the correct use of RCDs
5. MS 1979 - LV installation in buildings – Code of Practice
6. MS IEC 60364 - LV installation in buildings

4. ENVIRONMENTAL CONDITIONS



Normal indoor conditions expected in household and similar uses where:

1. Temperature range: $-5\text{ }^{\circ}\text{C}$ to $40\text{ }^{\circ}\text{C}$, with a ref. value of $(25 \pm 5)\text{ }^{\circ}\text{C}$;
2. Relative humidity: $< 50\%$ at $40\text{ }^{\circ}\text{C}$;
3. Air pressure: 70 kPa to 106 kPa (altitude $< 2000\text{ m}$);
4. Atmosphere: neither corrosive nor lacking of adequate ventilation; and
5. External magnetic field: < 5 times the earth's magnetic field in any direction.

5. GENERAL CONSIDERATIONS



Although availability of protection provided by RCDs or other electrical equipment depend on good design and high quality manufacturing, it must also be acknowledged that RCDs are not used alone, but form part of an electrical installation.

Factors relating to the installation and use of the electrical installation may influence the availability of protection or correct operation of electrical equipment such as RCDs after installation. This type of availability cannot be checked by tests in product standards and therefore requires periodic verification of installations.

5. GENERAL CONSIDERATIONS



1. To check installations, including the functioning of the RCD, during commissioning;
2. To regularly verify installations, electrical loads and electrical equipment including RCD equipment during the installation life and to replace failing loads and electrical equipment including RCDs;
3. To consider replacing loads or equipment, including RCDs, after a certain number of years depending on the conditions of use or installation.

6. SELECTION of RCDs

6.1 Types of RCD

RCDs are classified into different categories, as follows, in according with their ability to ensure protection against various types of earth fault currents:

1.Type AC

- for residual sinusoidal alternating currents



2.Type A

- as for type AC; and
- for residual pulsating direct currents

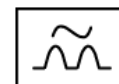



3.Type B & F (MS IEC-62423)

- as for type A; and
- for smooth DC

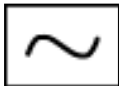

6. SELECTION of RCDs

6.1 Types of RCD

<p>AC Type</p> 	<p>A Type</p> 	<p>B & F Type</p> 
<p>for:</p> <ul style="list-style-type: none"> - pure AC current 	<p>for:</p> <ul style="list-style-type: none"> - pure AC current - pulsating DC 	<p>for:</p> <ul style="list-style-type: none"> - pure AC current - pulsating DC - smooth DC
<p>Applications:</p> <ul style="list-style-type: none"> - electrical devices (non-electronics) 	<p>Applications:</p> <ul style="list-style-type: none"> - electrical devices (electronics and non-electronics) 	<p>Applications:</p> <ul style="list-style-type: none"> - electrical devices - frequency inverters - computed tomography

6. SELECTION of RCDs

6.1 Types of RCD

'AC' Type

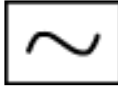

'A' Type

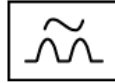

'B' Type

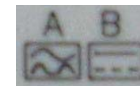
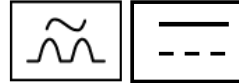

6. SELECTION of RCDs

6.2 Rated Residual Tripping Current /sensitivity ($I_{\Delta n}$)

RCDs can be provided with any value of rated residual operating current, ' $I_{\Delta n}$ '. However, the following are standard values used in MS and IEC standards:

6 mA, 10 mA, 30 mA, 100 mA, 300 mA and 500 mA.

NOTE. 30 mA is the maximum value permissible for personal shock protection, and 300 mA is the maximum value permissible for fire protection. If RCDs with non-standard values are used, the limits for shock protection and fire protection must not be exceeded.

6. SELECTION of RCDs



6.3 Selection of RCDs according to the type of protection

RCDs can be used where it is necessary to protect a circuit or an installation against dangerous residual currents. The three main areas for such protection are as follows:

1. Protection against fire.

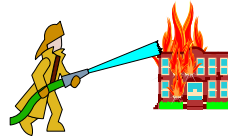

2. Fault protection (protection against indirect contact)



3. Basic protection (protection against direct contact)

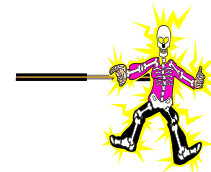

6.3.1 Fire protection



Tracking currents are linked to ageing of installations where a reduction in humidity and drying out of pollution at the surface of isolating materials may lead to a degradation of the isolating material and the deposit of carbon. This may cause fire.

Recommended to use RCDs having $I_{\Delta n}$ not higher than 300 mA at the beginning of installations. In domestic applications, where installations are not maintained, the use of such RCDs is highly recommended. For fire protection, the RCD must break all phase(s) and neutral. It may be an S Type RCD in order to allow discrimination with other RCDs downstream.

6.3.2 Fault protection (protection against indirect contact)

- Fault between a live part and earth
- Can cause exposed metal parts to reach a dangerous voltage.
- A person touching such live parts may be exposed to a potentially fatal shock risk, so the fault must be eliminated.
- This is referred to as protection against indirect contact.
- Choice of RCD must follow recommendations made in MS IEC 60364. In general, a medium sensitivity RCD can be selected for this type of fault protection.

e.g. An RCD with a rated residual operating current of up to 300 mA. If this value is appropriate it is possible to use a single RCD for fire protection and fault protection (protection against indirect contact)

6.3.3 Basic protection (protection against direct contact)

- Direct contact between a person and a live conductor, a residual current will flow through the body of the person.
- This current may cause a fatality if not eliminated quickly.
- An RCD having $I_{\Delta n}$ not higher than 30 mA will provide adequate protection in this situation (additional protection against electric shock).

In a domestic application, a 30 mA RCD used at the origin of the installation can provide efficient protection covering fire protection, fault protection and basic protection. For basic protection the RCD should not be a delayed type (selective type).

7. EFFECTS of ELECTRICITY ON HUMAN BODY



① Tripping characteristic 30mA RCD

No harmful effects ②

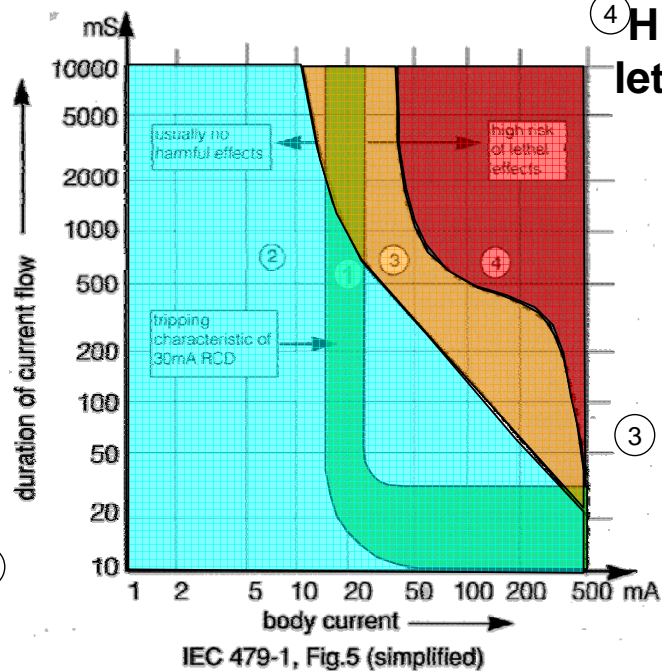

④ High risk of lethal effects

③ Dangerous level

8. TRIPPING of RCDs

8.1 Unwanted tripping

RCDs may be prone to unwanted tripping due to a number of factors.

The most common are as follows:

1. impact of standing leakage currents on the installation;
2. impact of harmonics and high frequency leakage currents;
3. impact of transient residual currents on an installation (switching);
4. surge currents caused by lightning strikes.



8.2 Minimizing Unwanted tripping

8.2.1 Discrimination

To ensure that a residual current on a sub-circuit causes only the RCD protecting the sub-circuit to trip and does not cause the upstream RCD to trip unless the fault is sustained beyond a certain time.

Discrimination is based on two conditions that have to be fulfilled:

1. Minimum non-actuating time of the upstream RCD shall be higher than the maximum break time of the RCDs installed downstream;
2. The rated residual operating current of the upstream RCD shall be at least 3 times the rated residual operating current of the RCDs installed down stream.

'S' type - 'G' type Discrimination

Table 1 IEC 61008-1

Type	I _n A	I _{Δn} A	Standard values of break times (s) and non-actuating times (s) at a residual current I _Δ equal to:				
			I _{Δn}	2 x I _{Δn}	5 x I _{Δn}	500A	
G	Any value	Any value	0.3	0.15	0.04	0.04	Maximum break times
S	> 25	> 0.03	0.5	0.2	0.15	0.15	Maximum break times
			0.13	0.06	0.05	0.04	Minimum non-actuating times

'S' type - 'G' type Discrimination

- Windows of operation at 150mA

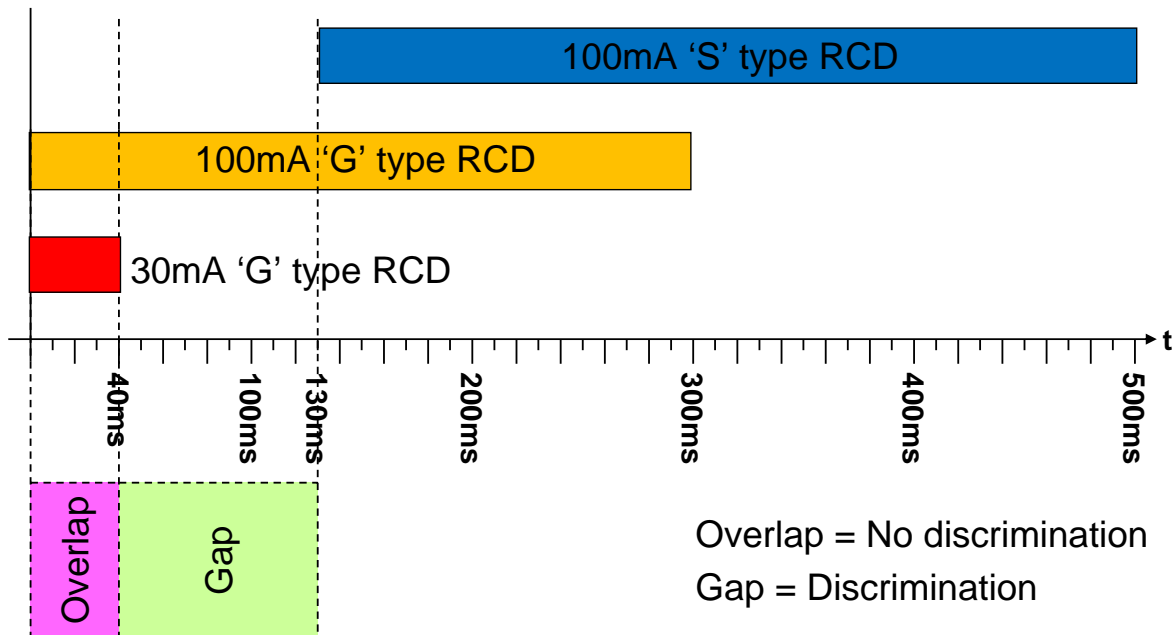

8.2 Minimizing Unwanted tripping

8.2.2 Use of surge protective devices (SPDs)

During the operation of SPD, large surge currents may flow to earth as a result of limiting transient over-voltages in the installation.

In the particular case when an SPD is connected downstream of an RCD, the resultant surge current to earth will be seen by the RCD as a residual current. In this situation, the RCD can trip.

RCD standards include two levels of immunity to surge currents:

1. G type RCD with a minimum surge current immunity of 200 A with a 0.5 μ s/100 kHz waveform;
2. S type RCD with a minimum surge current immunity of 3000 A with an 8/20 μ s waveform.

"HI-type" RCD can withstand a minimum surge current immunity of 6000 A

8.2 Minimizing Unwanted tripping

8.2.2 Use of surge protective devices (SPDs)

Therefore, the following is recommended:

1. In general, to install SPDs upstream of RCDs (RCDs installed upstream of SPDs may operate on the expected surge currents);
2. If SPDs are installed downstream of RCDs, the expected surge currents to earth should not exceed the immunity value of the RCD.

Use of surge protective devices (SPDs)

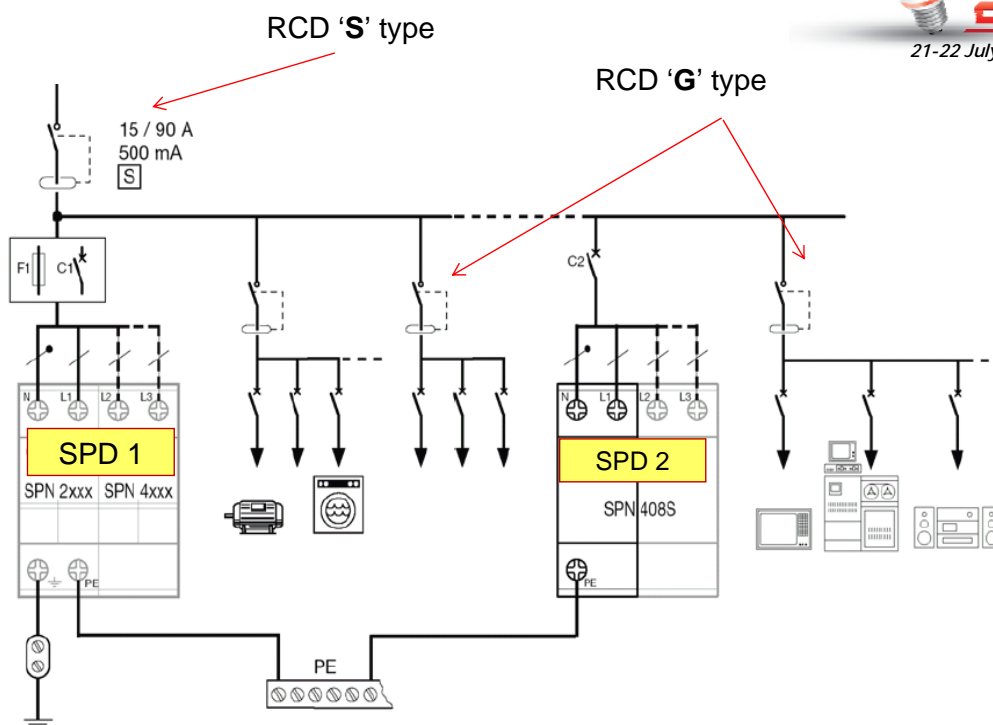

8.2 Minimizing Unwanted tripping



Impact of standing leakage current

Standing leakage currents in a circuit are usually either due to low insulation levels or to the presence of filters or capacitance between line and earth. Such standing leakage current can either be of rated frequency (50/60 Hz) or harmonics.

8.2 Minimizing Unwanted tripping



Estimated standing leakage current for electrical & electronics appliances:

1.0 mA to 2.0 mA	- for computers
0.5 mA to 1.0 mA	- for printers
0.5 mA to 0.75 mA	- for small portable appliances
0.5 mA to 1.0 mA	- for telecopiers/fax
0.5 mA to 1.5 mA	- for photocopiers
around 1.0 mA	- for filters

Calculation of the total leakage current from different appliances does not follow an arithmetic sum and needs to be corrected by a factor of 0.7/0.8.

8.2 Minimizing Unwanted tripping

Impact of standing leakage current

As the operating range of RCDs is normally from $0.5 I_{\Delta n}$ to $1 I_{\Delta n}$ it is recommended that the standing leakage current in a circuit does not exceed $0.3 I_{\Delta n}$ of the protective RCD at the rated frequency. In cases of leakage currents $>0.3 I_{\Delta n}$, it is recommended to divide the protected circuit into sub-circuits and install an RCD on each sub-circuit.

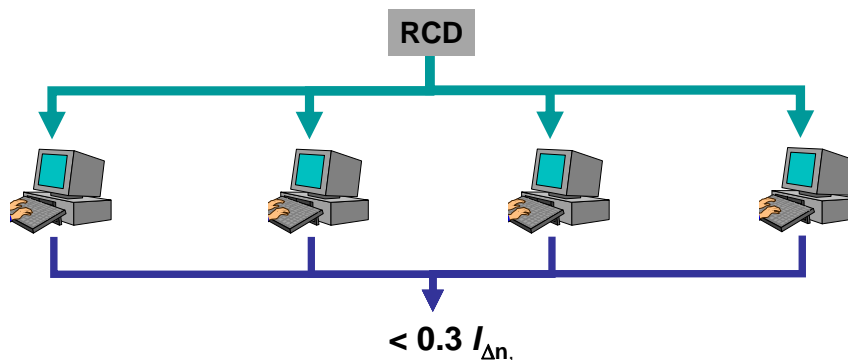

8.2 Minimizing Unwanted tripping

Impact of standing leakage current

How many computers can be connected to a 100mA RCCB?

Max. allowable residual leakage = $100\text{mA} \times 30\% = 30\text{mA}$

No. of computers = $30 / 2 = 15$

= 15 computers only

Hints:

Each computer has 2 mA standing leakage current.

Factor = 1

8.2 Minimizing Unwanted tripping

Impact of harmonics and high frequency leakage current

High frequency leakage currents can be produced by particular equipment, such as electronic ballasts, frequency inverters, etc.

Impact of transient residual currents

Transient residual currents generally have paths to earth through:

- Surge protective devices (SPDs).
- Capacitances.

When surge voltages occur between phase(s) and earth or neutral and earth, surge current flows to earth through the common mode capacitances. Lightning & Switching operations can produce large transient overvoltages.

9. RCCB – THE PROBLEMS (summary)

1. NUISANCE TRIPPING

- SURGE (Lightning or Switching)
- STANDING LEAKAGE CURRENT
- EMF INTERFERENCE

2. INDISCRIMINATE TRIPPING

3. CONTACTS MELTED/BURNT

4. NO TRIPPING

- INSENSITIVE (Numb)
- LOW VOLTAGE (only for test button)
- DIFFERENT WAVEFORM

10. RCCB – THE SOLUTIONS (summary)



1. NUISANCE TRIPPING

- a. Due to surges
 - a. Install an SPD before the RCCB
 - b. Choose RCCB with higher surge immunity (HI-type or S-type)
 - c. Install an auto-reset device



10. RCCB – THE SOLUTIONS (summary)



1. NUISANCE TRIPPING

- b. Due to standing residual current
 - a. Reduce electronics load per RCCB (use 30% $I_{\Delta n}$ rule)
 - b. Install RCCB with higher $I_{\Delta n}$

2. INDISCRIMINATE TRIPPING

- a. Employ a proper discrimination practice
 - a. RCCB up-stream must be at least with 3 X $I_{\Delta n}$
 - b. Use S-type RCCB up-stream
 - c. Use 30% $I_{\Delta n}$ rule

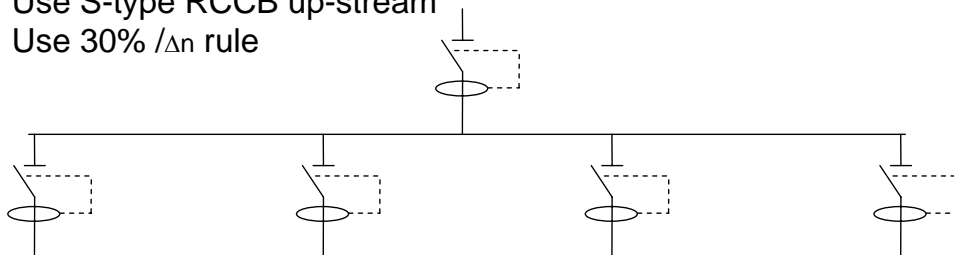

10. RCCB – THE SOLUTIONS (summary)

3. CONTACT MELTED/BURNT

Due to over-current (short circuit or overload)

- a. Install a circuit breaker before the RCCB
- b. Choose an RCCB with the same or higher rated current than the upstream circuit breaker

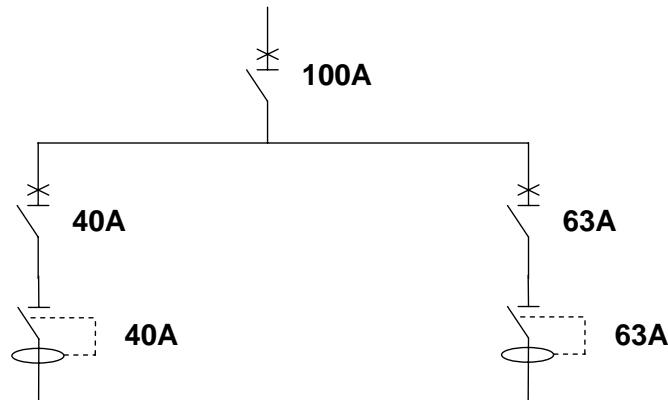

10. RCCB – THE SOLUTIONS (summary)

4. NO TRIPPING

Choose the correct RCCB according to load type

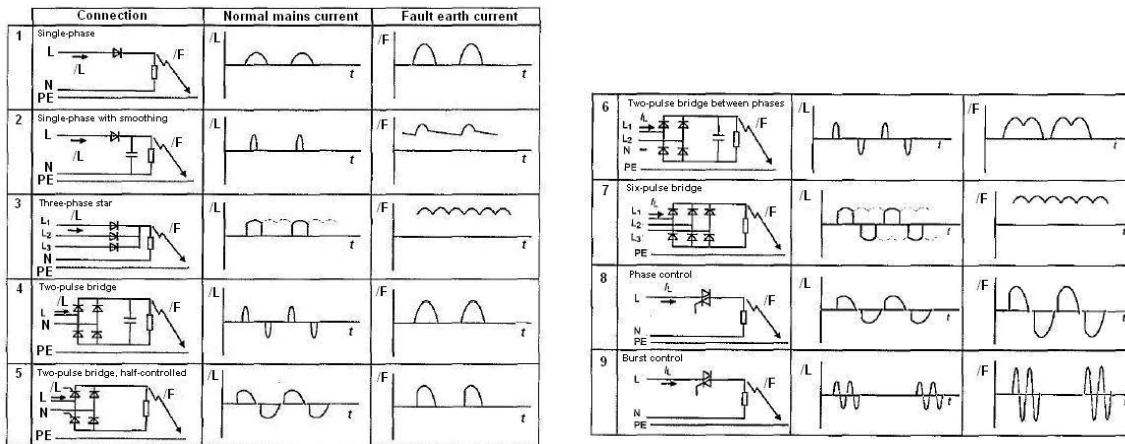

Fault current in connections with semiconductor devices

Type AC RCDs - protection against residual currents shown in 8 & 9.

Type A RCDs - protection against residual currents shown in 1, 4, 5, 8 & 9.

Type B RCDs - protection against residual currents shown in 1 – 9.



Thank you for
your attention!